

TATÉ
MEDICAL

Thrombus Aspiration Catheter

ASPICATH



Biometrix 4th Generation Thrombus Aspiration Catheters.
Reliability, Predictability, Quality.

Thrombus Aspiration Catheter



Aspiration Catheter Set

The Biometrix Thrombus Aspiration Catheter incorporates a smooth tip design to increase pushability and a unique hydrophilic coating to escalate trackability

The Aspicath's excellent pushability is also due to the innovative shaft design and the kink resistance, specifically designed for aspiration catheters.

Indicated for use in the central and peripheral circulatory system, including saphenous vein grafts to contain and aspirate embolic material (thrombus/debris) while performing PTCA, PTA or stenting procedures.

Code	Description	Qty/Box
BG-A6F-ASPICATH	6F Aspiration Catheter	1
BG-A7F-ASPICATH	7F Aspiration Catheter	1
Technical Data		Aspicath 6F
Range	6F	7F
Wire compatibility	0.014" (0.36 mm)	0.014" (0.36 mm)
Wire compatibility	145 cm	145 cm
Distal part flexibility/trackability	Pebax flexibility	Pebax flexibility
Proximal part push/kinking resistance	Reinforced PEEK for support	Reinforced PEEK for support
Outer diameter (O.D.)	0.067" (1.70 mm)	0.078" (1.98 mm)
Extraction lumen area (Proximal)	0.95 mm ²	1.54 mm ²
Extraction lumen area (Distal)	0.93 mm ²	1.43 mm ²
Aspiration speed	1.6cc/s	2.8cc/s

Important information:

Prior to use, refer to the "instructions for use" supplied with these devices for indications, contraindications, side effects, suggested procedures, warnings and precautions.

For healthcare professionals only. Class III medical device."

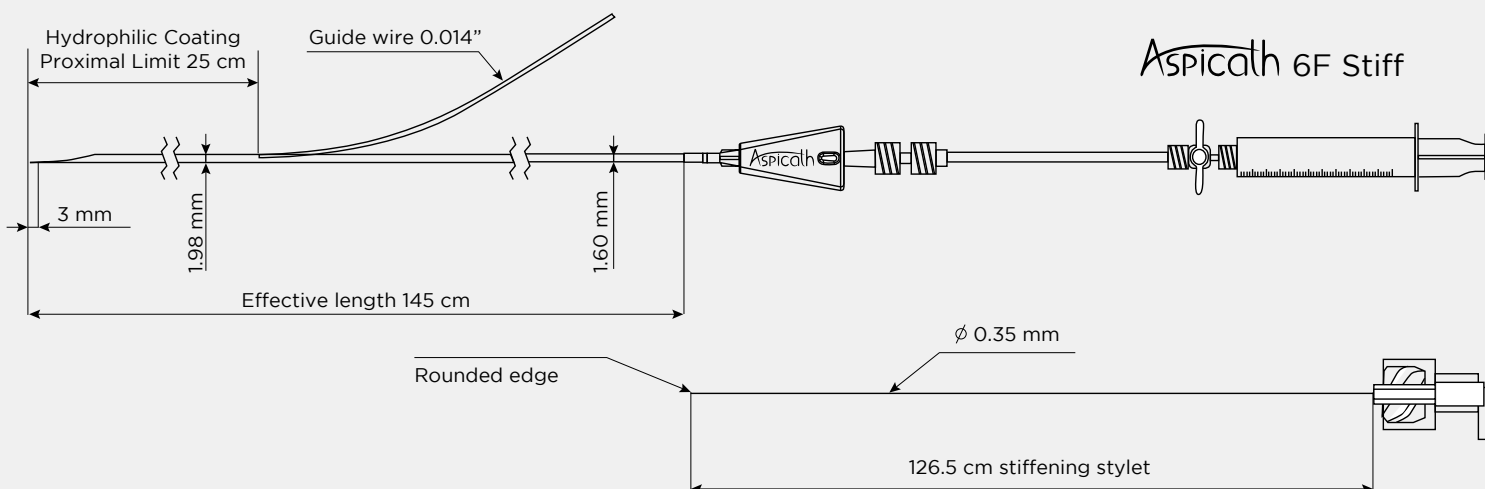

Distributed exclusively by:

TATÉ MEDICAL
Taté Medical Ltd.
 11 Sderot Nisiye Yisrael St. Karmiel, Israel
 info@tate-med.com
 www.tate-med.com



TATÉ
MEDICAL

Ceto RX PTCA Dilatation Balloon Catheter

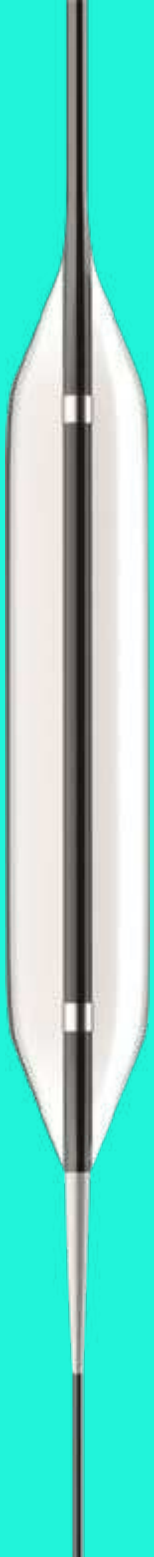

Ceto

Biometrix RX PTCA Dilatation Balloon Catheter provides the best solution for coronary angioplasty procedures.

Ceto RX PTCA Dilatation Balloon Catheter

Biometrix RX PTCA Dilatation balloon catheter is semi-compliant. It is used for dilatation of clogged coronary blood vessels in angioplasty procedures.

The catheter has excellent pushability features and a flexible tapered tip. With optimal trackability and an innovative hydrophilic coating (FC) it is fit for the tightest occlusion crossings.

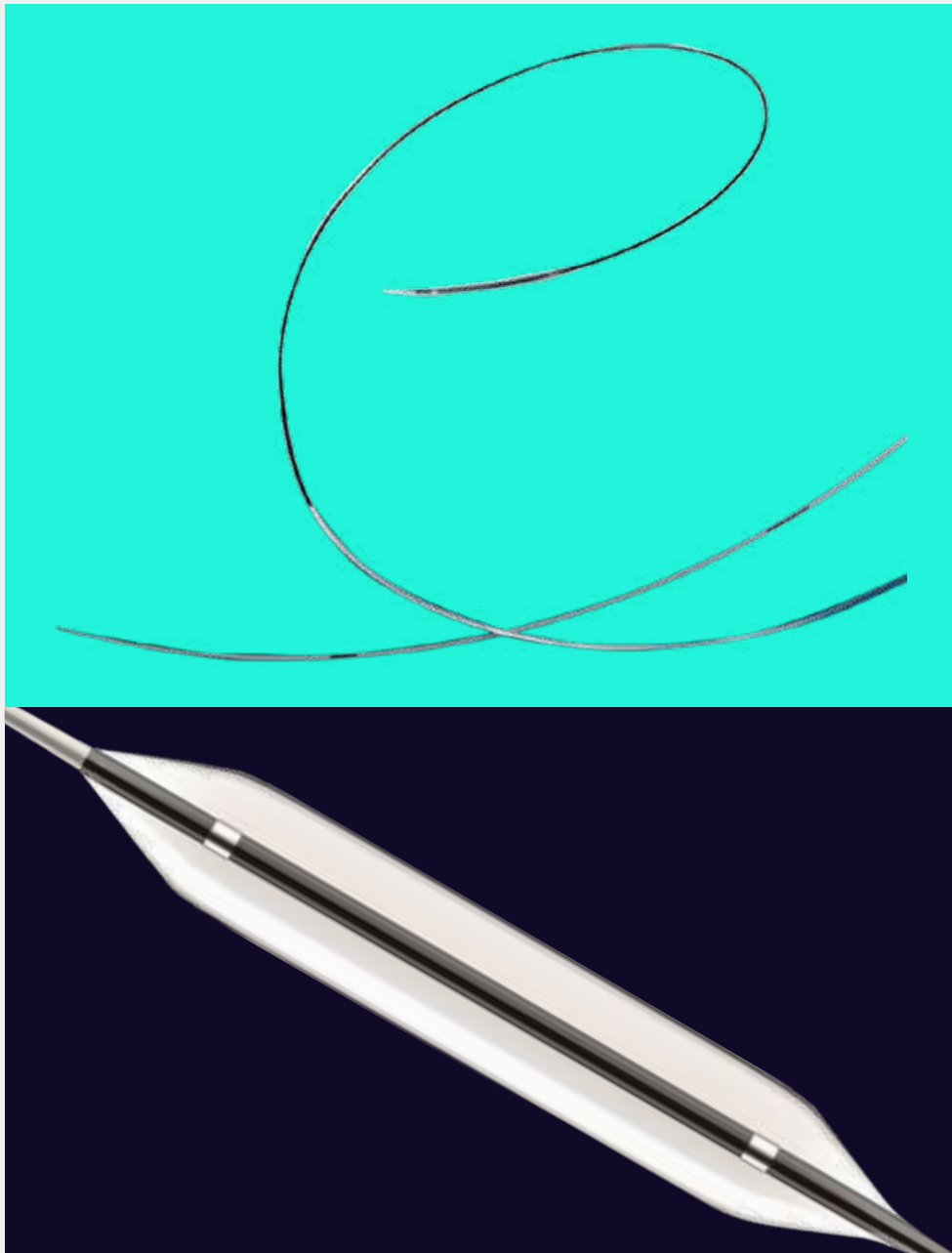

Innovative Flexible Tip for the Tightest Occlusion Crossing



Code	Balloon Diameter	Balloon Length
BG-C15010-CETO	1.5 mm	10 mm
BG-C15015-CETO	1.5 mm	15 mm
BG-C15020-CETO	1.5 mm	20 mm
BG-C15030-CETO	1.5 mm	30 mm
BG-C20010-CETO	2 mm	10 mm
BG-C20015-CETO	2 mm	15 mm
BG-C20020-CETO	2 mm	20 mm
BG-C20030-CETO	2 mm	30 mm
BG-C22510-CETO	2.25 mm	10 mm
BG-C22515-CETO	2.25 mm	15 mm
BG-C22520-CETO	2.25 mm	20 mm
BG-C22530-CETO	2.25 mm	30 mm
BG-C25010-CETO	2.5 mm	10 mm
BG-C25015-CETO	2.5 mm	15 mm
BG-C25020-CETO	2.5 mm	20 mm
BG-C25030-CETO	2.5 mm	30 mm
BG-C30010-CETO	3 mm	10 mm
BG-C30015-CETO	3 mm	15 mm
BG-C30020-CETO	3 mm	20 mm
BG-C30030-CETO	3 mm	30 mm
BG-C35010-CETO	3.5 mm	10 mm
BG-C35015-CETO	3.5 mm	15 mm
BG-C35020-CETO	3.5 mm	20 mm
BG-C35030-CETO	3.5 mm	30 mm
BG-C40010-CETO	4 mm	10 mm
BG-C40015-CETO	4 mm	15 mm
BG-C40020-CETO	4 mm	20 mm
BG-C40030-CETO	4 mm	30 mm

Qty/Box: 1



Ceto RX PTCA Dilatation Balloon Catheter

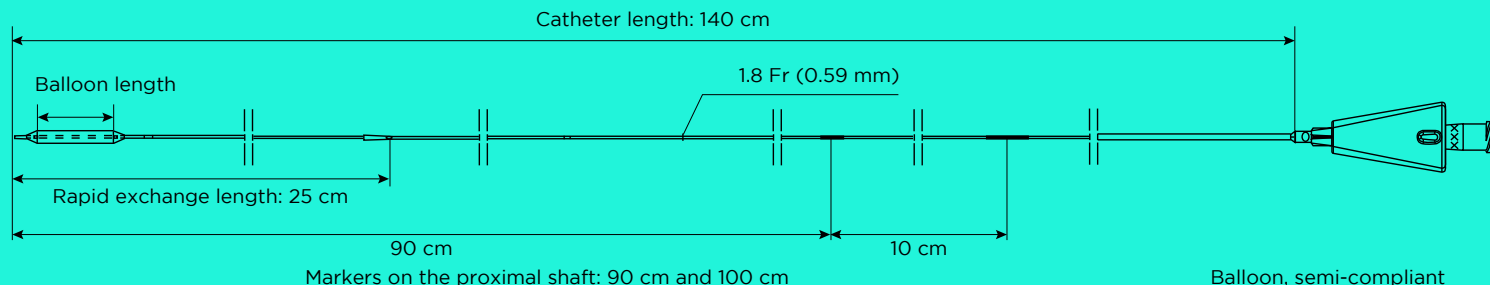

Diameter in mm												
Length in mm	1.50	2.00	2.25	2.50	2.75	3.00	3.25	3.50	3.75	4.00	4.50	5.00
8 mm	•	•	•	•	•	•	•	•	•	•	•	•
10 mm	•	•	•	•	•	•	•	•	•	•	•	•
15 mm	•	•	•	•	•	•	•	•	•	•	•	•
20 mm	•	•	•	•	•	•	•	•	•	•	•	•
25 mm	•	•	•	•	•	•	•	•	•	•	•	•
30mm	•	•	•	•	•	•	•	•	•	•	•	•
40 mm	•	•	•	•	•	•	•	•	•	•	•	•

Diameter in mm												
Pressure in ATM	1.50	2.00	2.25	2.50	2.75	3.00	3.25	3.50	3.75	4.00	4.50	5.00
2	1.39	1.85	2.09	2.32	2.55	2.78	3.01	3.24	3.48	3.71	4.17	4.63
4	1.44	1.92	2.16	2.40	2.64	2.88	3.12	3.36	3.60	3.84	4.32	4.80
6	1.50	2.00	2.25	2.50	2.75	3.00	3.25	3.50	3.75	4.00	4.50	5.00
8	1.54	2.05	2.31	2.56	2.82	3.07	3.33	3.58	3.84	4.09	4.60	5.12
10	1.57	2.09	2.35	2.61	2.87	3.13	3.39	3.65	3.91	4.17	4.69	5.22
12	1.59	2.12	2.39	2.65	2.92	3.18	3.45	3.71	3.98	4.24	4.77	5.30
14	1.62	2.16	2.43	2.70	2.97	3.24	3.51	3.78	4.05	4.32	4.86	5.40
16	1.65	2.20	2.48	2.75	3.03	3.30	3.58	3.85	4.13	4.40	4.95	5.50
18	1.68	2.24	2.52	2.80	3.08	3.36	3.64	3.92	4.20	4.48	5.04	5.60

■ Nominal Pressure (NP)
 ■ Rated Burst Pressure (RBP)
 Balloon size measured at 37° C



Glaucus RX PTA Balloon Catheter

Glaucus

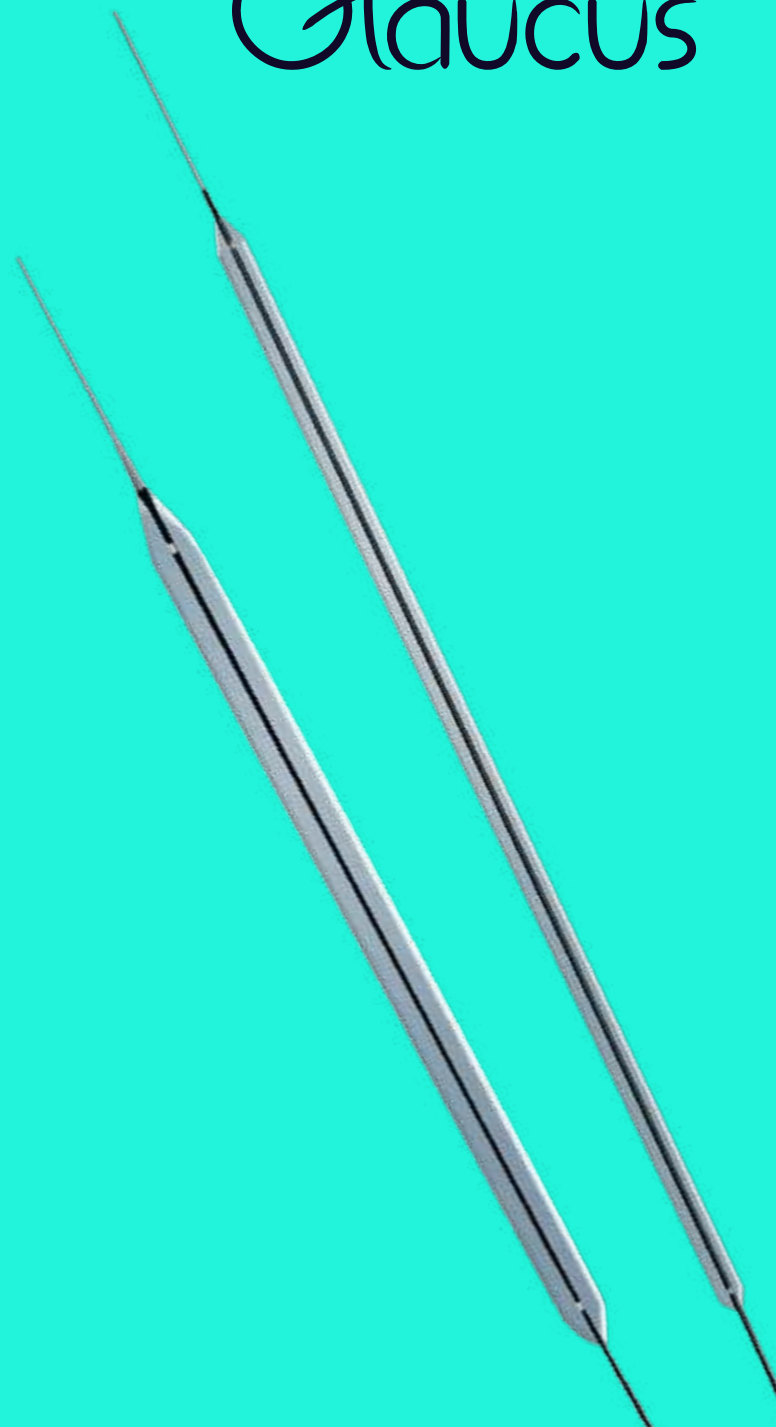

Introducing the Biometrix Rapid Exchange PTA Balloon Catheter. Fit for the toughest cases.

Glaucus RX PTA Balloon Catheter

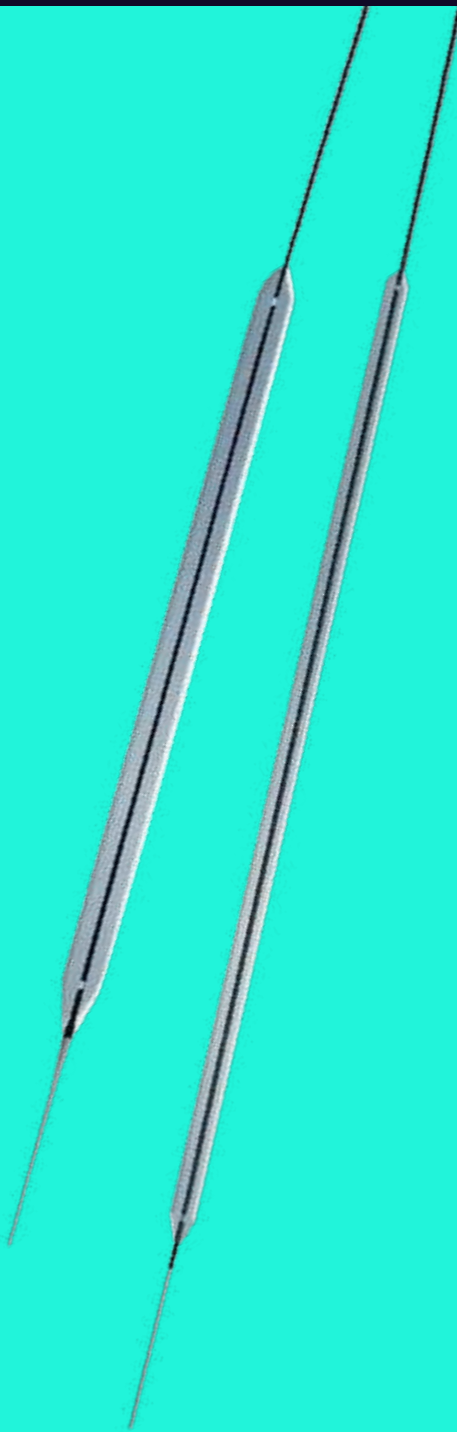

The Biometrix RX PTA Balloon Catheter is a semi-compliant device, designed to handle the most challenging angioplasty procedures.

The Glaucus tapered tip, rapid exchange catheter, with its innovative hydrophilic coating & optimal pushability, provides maximum ease of use & superior clinical outcomes for the dilatation of clogged peripheral blood vessels in angioplasty procedures.

The Glaucus soft and flexible tip of 0.016" enables the balloon to navigate more easily through complex and tortuous itineraries for outstanding lesion access.

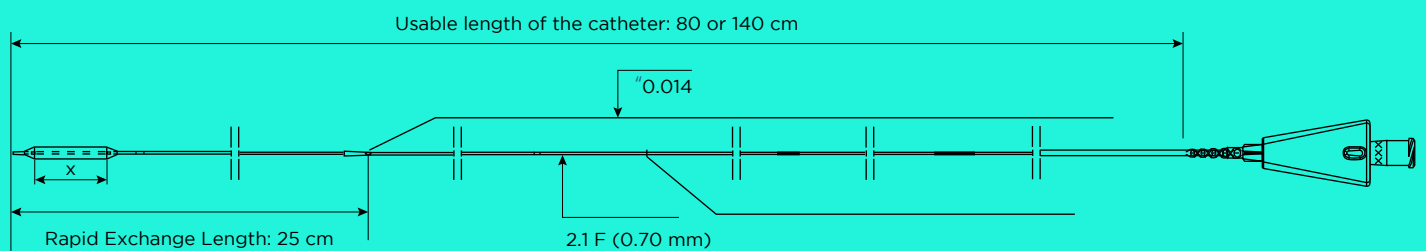

Glaucus RX PTA Balloon Catheter

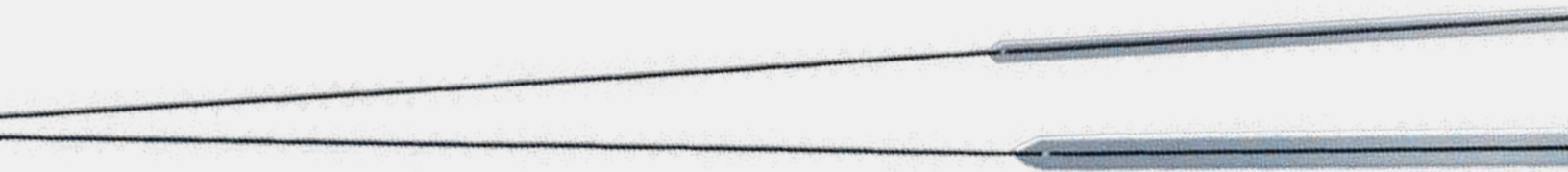

Glaucus Pressure Charts

Balloon diameter (mm)	2	4	6	8	10	12	14	16
2	1.88	1.94	2.00	2.03	2.06	2.09	2.12	2.15
2.25	2.12	2.18	2.25	2.28	2.32	2.35	2.39	2.42
2.5	2.36	2.43	2.50	2.54	2.58	2.61	2.65	2.69
2.75	2.59	2.67	2.75	2.79	2.83	2.87	2.92	2.96
3	2.83	2.91	3.00	3.05	3.09	3.14	3.18	3.23
3.5	3.30	3.40	3.50	3.55	3.61	3.66	3.71	3.76
4	3.77	3.88	4.00	4.06	4.12	4.18	4.24	4.30
4.5	4.24	4.37	4.50	4.57	4.64	4.70	4.77	4.84
5	4.80	4.90	5.00	5.08	5.15	5.23	5.30	5.38
6	5.76	5.88	6.00	6.09	6.18	6.27	6.36	6.45
7	6.72	6.86	7.00	7.11	7.21	7.32	7.42	7.53

Glaucus Pressure Charts

Length (mm)	2.0	2.25	2.5	2.75	3.0	3.5	4.0	4.5	5.0	6.0	7.0
8											
10											
20											
30											
40											
60											
80											
120											
150										16 Bars	
200										14 Bars	

Ordering Information

Code	Balloon Diameter	Balloon Length
BG-G200008-GLAU	2 mm	8 mm
BG-G200010-GLAU	2 mm	10 mm
BG-G200020-GLAU	2 mm	20 mm
BG-G200030-GLAU	2 mm	30 mm
BG-G200040-GLAU	2 mm	40 mm
BG-G200060-GLAU	2 mm	60 mm
BG-G200080-GLAU	2 mm	80 mm
BG-G200100-GLAU	2 mm	100 mm
BG-G200120-GLAU	2 mm	120 mm
BG-G200150-GLAU	2 mm	150 mm
BG-G200200-GLAU	2 mm	200 mm
BG-G225008-GLAU	2.25 mm	8 mm
BG-G225010-GLAU	2.25 mm	10 mm
BG-G225020-GLAU	2.25 mm	20 mm
BG-G225030-GLAU	2.25 mm	30 mm
BG-G225040-GLAU	2.25 mm	40 mm
BG-G225060-GLAU	2.25 mm	60 mm
BG-G225080-GLAU	2.25 mm	80 mm
BG-G225100-GLAU	2.25 mm	100 mm
BG-G225120-GLAU	2.25 mm	120 mm
BG-G225150-GLAU	2.25 mm	150 mm
BG-G225200-GLAU	2.25 mm	200 mm
BG-G250008-GLAU	2.5 mm	8 mm
BG-G250010-GLAU	2.5 mm	10 mm
BG-G250020-GLAU	2.5 mm	20 mm
BG-G250030-GLAU	2.5 mm	30 mm
BG-G250040-GLAU	2.5 mm	40 mm
BG-G250060-GLAU	2.5 mm	60 mm
BG-G250080-GLAU	2.5 mm	80 mm
BG-G250100-GLAU	2.5 mm	100 mm
BG-G250120-GLAU	2.5 mm	120 mm
BG-G250150-GLAU	2.5 mm	150 mm
BG-G250200-GLAU	2.5 mm	200 mm
BG-G275008-GLAU	2.75mm	8 mm
BG-G275010-GLAU	2.75mm	10 mm
BG-G275020-GLAU	2.75mm	20 mm
BG-G275030-GLAU	2.75mm	30 mm
BG-G275040-GLAU	2.75mm	40 mm
BG-G275060-GLAU	2.75mm	60 mm
BG-G275080-GLAU	2.75mm	80 mm
BG-G275100-GLAU	2.75mm	100 mm
BG-G275120-GLAU	2.75 mm	120 mm
BG-G275150-GLAU	2.75 mm	150 mm
Qty/Box: 1		

Code	Balloon Diameter	Balloon Length
BG-G300008-GLAU	3 mm	8 mm
BG-G300010-GLAU	3 mm	10 mm
BG-G300020-GLAU	3 mm	20 mm
BG-G300030-GLAU	3 mm	30 mm
BG-G300040-GLAU	3 mm	40 mm
BG-G300060-GLAU	3 mm	60 mm
BG-G300080-GLAU	3 mm	80 mm
BG-G300100-GLAU	3 mm	100 mm
BG-G300120-GLAU	3 mm	120 mm
BG-G300150-GLAU	3 mm	150 mm
BG-G350008-GLAU	3.50 mm	8 mm
BG-G350010-GLAU	3.50 mm	10 mm
BG-G350020-GLAU	3.50 mm	20 mm
BG-G350030-GLAU	3.50 mm	30 mm
BG-G350040-GLAU	3.50 mm	40 mm
BG-G350060-GLAU	3.50 mm	60 mm
BG-G350080-GLAU	3.50 mm	80 mm
BG-G350100-GLAU	3.50 mm	100 mm
BG-G350120-GLAU	3.50 mm	120 mm
BG-G350150-GLAU	3.50 mm	150 mm
BG-G400008-GLAU	4 mm	8 mm
BG-G400010-GLAU	4 mm	10 mm
BG-G400020-GLAU	4 mm	20 mm
BG-G400030-GLAU	4 mm	30 mm
BG-G400040-GLAU	4 mm	40 mm
BG-G400060-GLAU	4 mm	60 mm
BG-G400080-GLAU	4 mm	80 mm
BG-G400100-GLAU	4 mm	100 mm
BG-G400120-GLAU	4 mm	120 mm
BG-G450010-GLAU	4.50 mm	10 mm
BG-G450020-GLAU	4.50 mm	20 mm
BG-G450030-GLAU	4.50 mm	30 mm
BG-G450040-GLAU	4.50 mm	40 mm
BG-G450060-GLAU	4.50 mm	60 mm
BG-G450080-GLAU	4.50 mm	80 mm
BG-G600010-GLAU	6 mm	10 mm
BG-G600020-GLAU	6 mm	20 mm
BG-G600030-GLAU	6 mm	30 mm
BG-G600040-GLAU	6 mm	40 mm
BG-G700010-GLAU	7 mm	10 mm
BG-G700020-GLAU	7 mm	20 mm
BG-G700030-GLAU	7 mm	30 mm
BG-G700040-GLAU	7 mm	40 mm
Qty/Box: 1		



Taté Medical Ltd.
 11 Sderot Nisiye Yisrael St. Karmiel, Israel
info@tate-med.com
www.tate-med.com

